





<b>Connettore diritto</b> 	<b>Riferimento</b>	<b>ø mm</b>	<b>ø Pollici</b>
	101900	4	3/16"
	101901	10	3/8"
	101902	12	1/2"
	101903	15	5/8"
	101904	19	3/4"
	101905	22	7/8"

<b>Connettore a T</b> 	<b>Riferimento</b>	<b>ø mm</b>	<b>ø Pollici</b>
	101928	4	3/16"
	101929	6	1/4"
	101930	8	5/16"
	101931	10	3/8"
	101932	12	1/2"
	101933	15	5/8"
101934	19	3/4"	





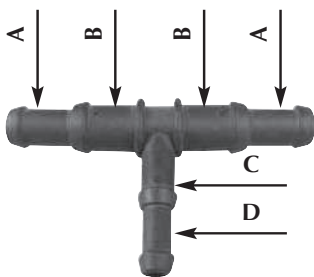



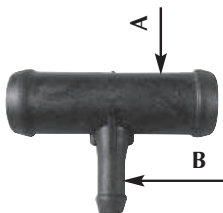



<b>Connettore a L</b> 	<b>Riferimento</b>	<b>ø mm</b>	<b>ø Pollici</b>
	101911	10	3/8"
	101912	12	1/2"
	101913	15	5/8"
	101914	19	3/4"

<b>Riduttore diritto</b> 	<b>Riferimento</b>	<b>ø Pollici/mm</b>	<b>Ø Pollici/mm</b>
	101920	3/8" (10mm)	1/2" (12mm)
	101921	1/2" (12mm)	5/8" (15mm)
	101922	5/8" (15mm)	3/4" (19mm)

<b>Riduttore universale a T</b> 				
	<b>A</b>	<b>B</b>	<b>C</b>	<b>D</b>

<b>Riferimento</b>	<b>A</b>	<b>B</b>	<b>C</b>	<b>D</b>
101935	1/2" (13mm)	5/8" (15mm)	3/8" (10mm)	5/16" (8mm)
101936	3/4" (19mm)	7/8" (22mm)	1/2" (12mm)	3/8" (10mm)

<b>Connettore a T</b> 	<b>Riferimento</b>	<b>A</b>	<b>B</b>
	101885	3/4" (19mm)	5/16" (8mm)

Riferimento	Descrizione	Immagine
101050	Spinotto	
101051	Fermo	
101052	Guarnizione O-ring	
101949	Adattatore maschio	
101950	5/16" 8mm	
101951	3/8" 10mm	
101952	1/2" 12mm	
101953	5/8" 15mm	
101954	3/4" 19mm	
101955	7/8" 22mm	
101956	1" 25mm	
101957	1. 1/4" 32mm	

	Riferimento	Ø Pollici	Ø mm
	101941	1"	25mm
	101942	1. 1/4"	32mm
	101943	1. 1/2"	38mm

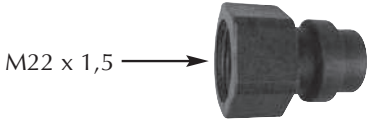
	Riferimento		Ø mm
	101049	Adattatore	M22 x 1,5

**Dimostrazione**



**Connettore a Y**  
**101940**



**Connettore a croce**  
**101944**

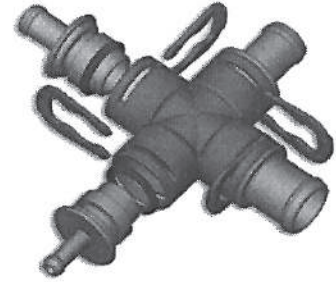

**Connettore a T**  
**101945**

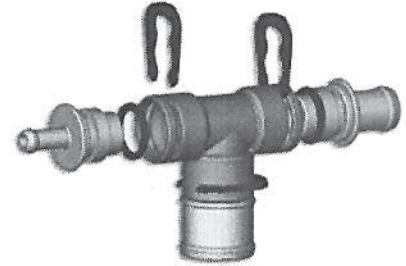

**Connettore dritto**  
**101946**



**Connettore a gomito ruotabile**  
**101947**

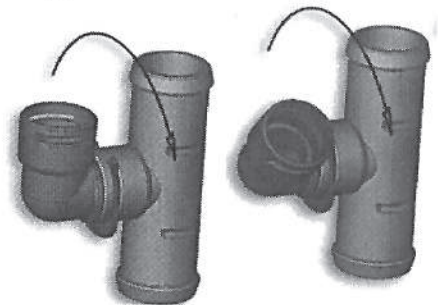

**Connettore a gomito**  
**101948**



Rif. 101947

Rif. 101943

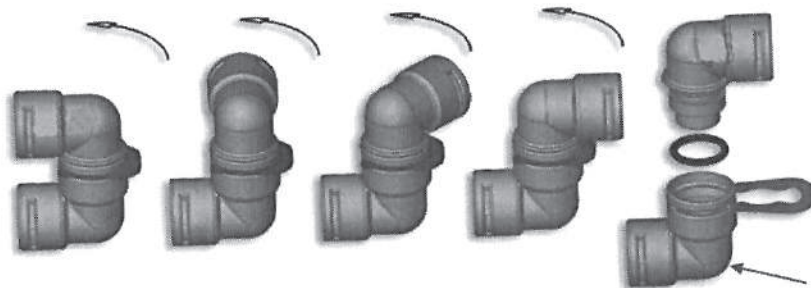
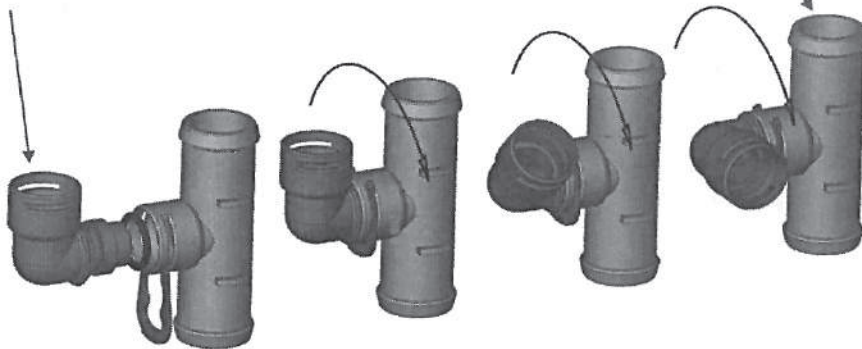

Rif. 101948

Rif. 101949

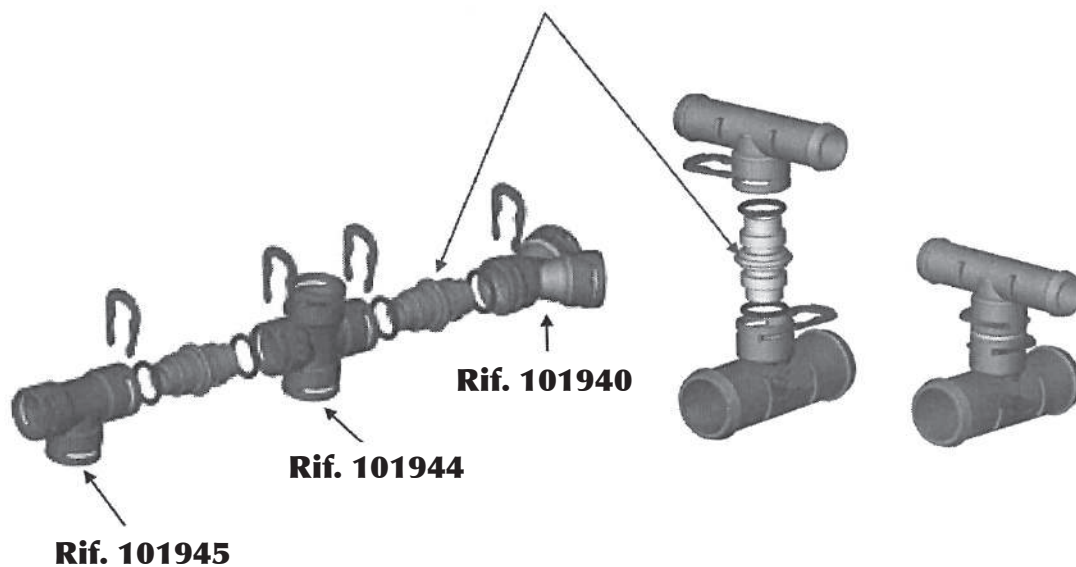

# 101810KIT

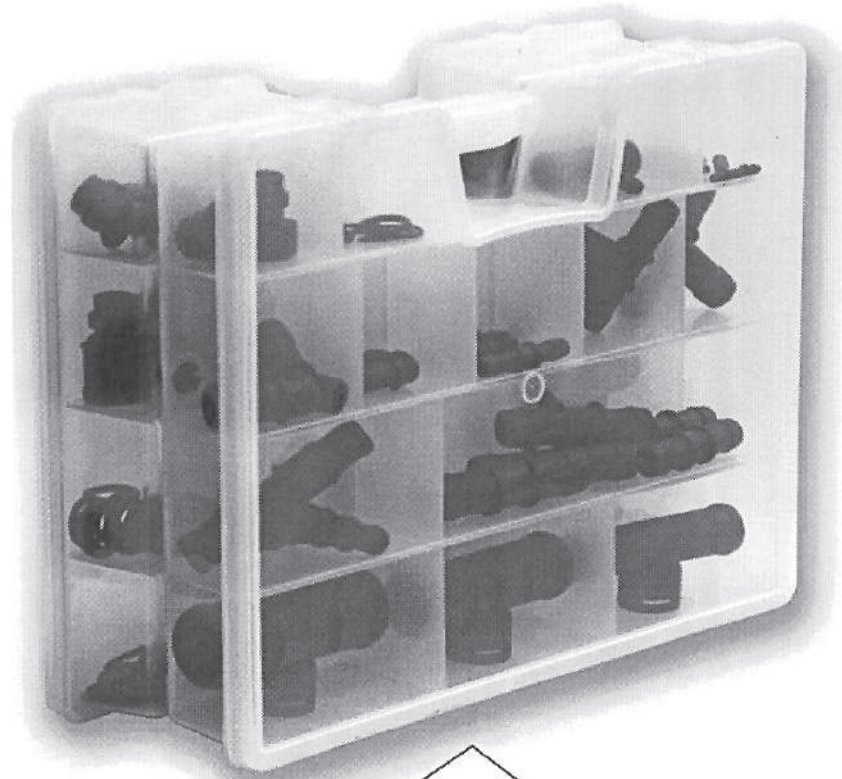

Rif.	Dimensioni	Pz.	Rif.	Dimensioni	Pz.	Rif.	A	B	C	D	Pz.
101901	3/8" 10mm	1	101920	3/8" 10mm a 1/2" 12mm	1	101935	1/2" 12mm	5/8" 15mm	3/8" 10mm	1/4" 6mm	1
101902	1/2" 12mm	1	101921	1/2" 12mm a 5/8" 15mm	1	101936	3/4" 19mm	7/8" 22mm	1/2" 12mm	3/8" 10mm	1
101903	5/8" 15mm	1	101922	5/8" 15mm a 3/4" 19mm	1						
101904	3/4" 19mm	1									
101905	7/8" 22mm	1									
Rif.	Dimensioni	Pz.	Rif.	Dimensioni	Pz.	Rif.	Dimensioni	Pz.			
101941	1" 25mm	1	101942	1 1/4" 32mm	1	101943	1 1/2" 38mm	1			
Rif.	Dimensioni	Pz.	Rif.	Dimensioni	Pz.	Rif.	Dimensioni	Pz.			
101913	5/8" 15mm	1	101911	3/8" 10mm	1	101934	3/4" 19mm	1			
101914	3/4" 19mm	1	101912	1/2" 12mm	1	101932	1/2" 12mm	1			
			101933	5/8" 15mm	1	101929	1/4" 6mm	1			
						101930	5/16" 8mm	1			
						101931	3/8" 10mm	1			
Rif.	Dimensioni	Pz.									
101928	3/16" 4mm	2									
Rif.	Dimensioni	Pz.	Rif.	Dimensioni	Pz.						
101900	3/16" 4mm	2	101885		1						

Rif.	Dimensioni	Pz.	Rif.	Dimensioni	Pz.	Rif.	Dimensioni	Pz.
101052		25	101051		25	101945		1
						101946		1
Rif.	Dimensioni	Pz.	Rif.	Dimensioni	Pz.	Rif.	Dimensioni	Pz.
101940		1	101949		1	101944		1
						101947		1
Rif.	Dimensioni	Pz.	Rif.	Dimensioni	Pz.	Rif.	Dimensioni	Pz.
101940		1	101949		1	101944		1
						101947		1
Rif.	Dimensioni	Pz.	Rif.	Dimensioni	Pz.	Rif.	Dimensioni	Pz.
101953	5/8" 15mm	3	101954	3/4" 19mm	3	101955	7/8" 22mm	3
						101956	1" 25mm	3
						101957	1 1/4" 32mm	3
Rif.	Dimensioni	Pz.	Rif.	Dimensioni	Pz.	Rif.	Dimensioni	Pz.
101952	1/2" 12mm	3	101951	3/8" 10mm	3			

- Materiale Poliammide caricato con fibra di vetro
- Resistenza alla temperatura: -40° C - +130° C
- Resistenti a: Benzina, Gasolio, Olio, Gpl e Liquido Refrigerante
- Pressione massima di esercizio: 6 Bar